

- High Surge Current Rectifier Circuits
- Up to 1600 Volt Blocking Standard

Single- and three-phase diode circuits incorporate highly efficient thermal management to provide high surge capability, extended life, and reliable performance. Available in five circuits, all models come in an industry standard package, provide 2500 Vrms from all terminals to the baseplate, and are UL recognized (file no. E72445).

Manufactured in Crydom's ISO 9002 Certified facility for optimum product performance and reliability.

PART NUMBER IDENTIFICATION

Series Type	Current	Circuit Type	Voltage	
M50	60 - 60 Amps	(see schematic diagrams)	400 (120Vac)	1200 (480Vac)
	100 - 100 Amps	Example: TB	600 (240Vac)	1400 (530Vac)
			1000 (380Vac)	1600 (600Vac)

Example: M50100TB1200

MECHANICAL DIMENSIONS

All dimensions are in inches (millimeters)

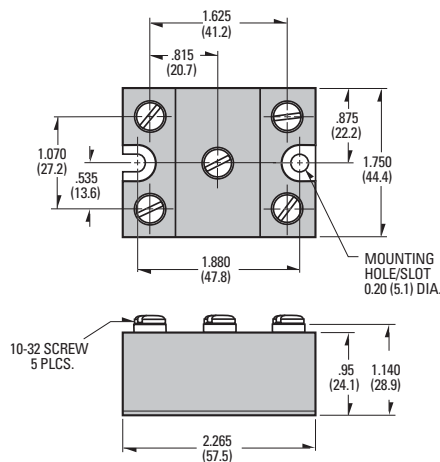

ELECTRICAL SPECIFICATIONS

SYMBOL	SPECIFICATION	RATINGS	
		M5060	M50100
I_D	Maximum DC Output Current ($T_c = 85^\circ\text{C}$)	60A	100A
V_F	Maximum Voltage Drop @ Amps Peak	1.35V @ 60A	1.2V @ 100A
T_J	Operating Junction Temperature Range	-40°C to +125°C	
V_{RRM}	(Repetitive Peak Reverse Voltage (AC Line))	400 (120 Vac) 600 (240 Vac) 1000 (380 Vac) 1200 (480 Vac) 1400 (530 Vac) 1600 (600 Vac)	
I_{TSM}	Maximum Non-Repetitive Surge Current (1/2 Cycle, 60Hz)	800A	1500A
I^2T	Maximum I^2T for Fusing ($t=8.3\text{ms}$) [A^2sec]	2650	9350
$R_{\theta JC}$	Maximum Thermal Resistance Junction to Ceramic Base per Chip	0.45°C/W	0.3°C/W
V_{ISOL}	Isolation Voltage	2500 V _{RMS}	2500 V _{RMS}

MECHANICAL SPECIFICATIONS

Weight: (typical)

4.5 oz. (158g)

©2008 CRYDOM Inc., Specifications subject to change without notice.

- High Surge Current Rectifier Circuits
- Up to 1600 Volt Blocking Standard

PART NUMBER IDENTIFICATION

Series Type	Current	Circuit Type	Voltage	
M50	60 - 60 Amps	(see schematic diagrams)	400 (120Vac)	1200 (480Vac)
	100 - 100 Amps	Example: TB	600 (240Vac)	1400 (530Vac)
			1000 (380Vac)	1600 (600Vac)

Example: M50100TB1200

M50 DIODE CIRCUITS

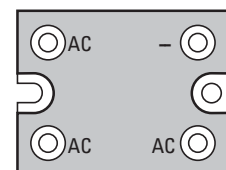
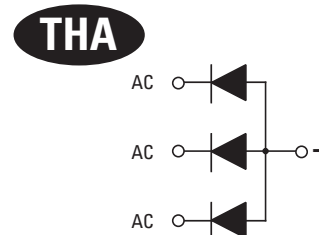
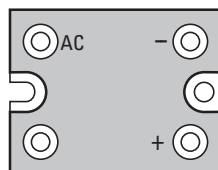
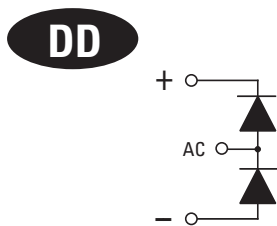
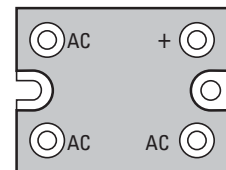
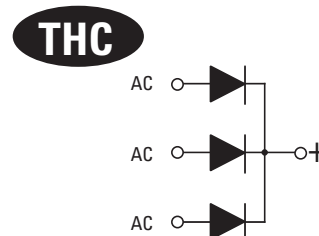
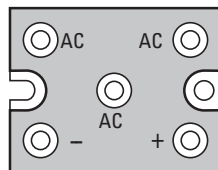
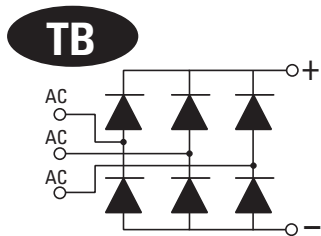
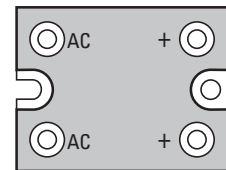
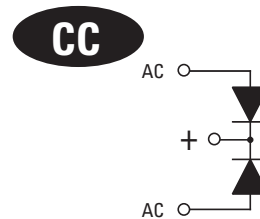
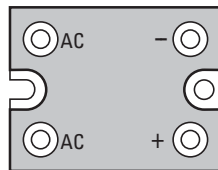
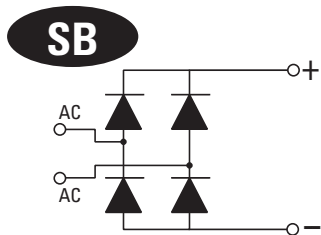

© 2008 CRYDOM Inc., Specifications subject to change without notice.

! DANGER / PELIGRO / DANGER /GEFAHR / PERICOLO / PERIGO

<p>HAZARD OF ELECTRIC SHOCK, EXPLOSION, OR ARC FLASH.</p> <ul style="list-style-type: none"> • Disconnect all power before installing or working with this equipment. • Verify all connections and replace all covers before turning on power. <p>Failure to follow these instructions will result in death or serious injury.</p>	<p>RIESGO DE DESCARGA ELECTRICA O EXPLOSION.</p> <ul style="list-style-type: none"> • Desconectar todos los suministros de energia a este equipo antes de trabajar con este equipo. • Verificar todas las conexiones y colocar todas las tapas antes de energizar el equipo. <p>El incumplimiento de estas instrucciones puede provocar la muerte o lesiones serias.</p>	<p>RISQUE DE DESCARGE ELECTRIQUE OU EXPLOSION</p> <ul style="list-style-type: none"> • Eteindre toutes les sources d'énergie de cet appareil avant de travailler dessus de cet appareil • Vérifier tous connections, et remettre tous couverts en place avant de mettre sous <p>De non-suivi de ces instructions provoquera la mort ou des lésions sérieuses.</p>	<p>GEFAHR EINES ELEKTRISCHEN SCHLAGES ODER EINER EXPLOSION.</p> <ul style="list-style-type: none"> • Stellen Sie jeglichen Strom ab, der dieses Gerät versorgt, bevor Sie an dem Gerät Arbeiten durchführen • Vor dem Drehen auf Energie alle Anschlüsse überprüfen und alle Abdeckungen ersetzen. <p>Unterlassung dieser Anweisungen können zum Tode oder zu schweren Verletzungen führen.</p>	<p>RISCHIO DI SCOSSA ELETTRICA O DELL'ESPLOSIONE.</p> <ul style="list-style-type: none"> • Spenga tutta l'alimentazione e che fornisce questa apparecchiatura prima del lavorare a questa apparecchiatura • Verificare tutti i collegamenti e sostituire tutte le coperture prima della rotazione sull'alimentazione <p>L'omissione di seguire queste istruzioni provocherà la morte o di lesioni serie</p>	<p>RISCO DE DESCARGA ELÉTRICA OU EXPLOÇÃO</p> <ul style="list-style-type: none"> • Desconectar o equipamento de toda a energia antes de instalar ou trabalhar com este equipamento • Verificar todas as conexões e recolocar todas as tampas antes de religar o equipamento <p>O não cumprimento destas instruções pode levar à morte ou lesões sérias.</p>
--	--	---	---	---	---

! WARNING / AVERTISSEMENT / WARNUNG /ADVERTENCIA / AVVERTENZA / AVISO

<p>RISK OF MATERIAL DAMAGE AND HOT ENCLOSURE</p> <ul style="list-style-type: none"> • The product's side panels may be hot, allow time for product to cool before touching. • Follow proper mounting instructions including torque values. • Do not allow liquids or foreign objects to enter this product. <p>Failure to follow this instruction can result in serious injury, or equipment damage.</p>	<p>RISQUE DE DOMMAGE MATERIEL ET DE SURCHAUFFE DU BOITIER</p> <ul style="list-style-type: none"> • Les panneaux latéraux du produit peuvent être chauds. Laisser le produit refroidir avant de le toucher. • Respecter les consignes de montage, et notamment les couples de serrage. • Ne pas laisser pénétrer de liquide ni de corps étrangers à l'intérieur du produit. <p>Le non-respect de cette directive peut entraîner, des lésions corporelles graves ou des dommages matériels.</p>	<p>GEFAHR VON MATERIALSCHÄDEN UND GEHÄUSEERHITZUNG</p> <ul style="list-style-type: none"> • Die Seitenwände können heiß sein. Lassen Sie das Produkt abkühlen, bevor Sie es berühren. • Beachten Sie die Montageanweisungen, Führen Sie keine Flüssigkeiten und Fremdkörper in das Produkt ein. <p>Die Nichtbeachtung dieser Anweisung kann Körperverletzung oder Materialschäden zur Folge haben.</p>
<p>RIESGO DE DAÑOS MATERIALES Y DE SOBRECIENTAMIENTO DE LA UNIDAD</p> <ul style="list-style-type: none"> • Los paneles laterales del producto pueden estar calientes. Esperar que el producto se enfríe antes de tocarlo. • Respetar las instrucciones de montaje, y en particular los pares de apretado. • No dejar que penetren líquidos o cuerpos extraños en el producto. <p>Si no se respetan estas precauciones pueden producirse graves lesiones, daños materiales.</p>	<p>RISCHIO DI DANNI MATERIALI E D'INVOLUCRO CALDO</p> <ul style="list-style-type: none"> • I pannelli laterali dell'apparecchio possono scottare; lasciar quindi raffreddare il prodotto prima di toccarlo. • Seguire le istruzioni di montaggio corrette. • Non far entrare liquidi o oggetti estranei in questo apparecchio. <p>La mancata osservanza di questa precauzione può causare gravi rischi per l'incolumità personale o danni alle apparecchiature.</p>	<p>RISCO DE DANO MATERIAL E DE AQUECIMENTO</p> <ul style="list-style-type: none"> • Os painéis laterais do produto podem estar quentes; dê tempo ao produto para arrefecer antes de lhe tocar. • Siga devidamente as instruções de montagem. • Não permita a entrada de líquidos e de objectos estranhos no produto. <p>A não observância destas precauções pode provocar a morte, ferimentos graves ou danos materiais.</p>